

FRONTIER DECK DRAIN INSTRUCTIONS

Instructions applicable to all Stegmeier LLC removable top Deck Drains Products

SITE PREPARATION: GRADE SUBSOIL WITH APPROPRIATE FALL TOWARD DRAIN AREA



A. Using a string line, drive 3 inch stakes along the path of the drain every 30 inches.



B. Using P.V.C. primer and cement on both the drain and the couplings, weld them into one piece.



C. Using nails or sheet rock screws, fasten the drain to the 3 inch stakes that have been set to grade.

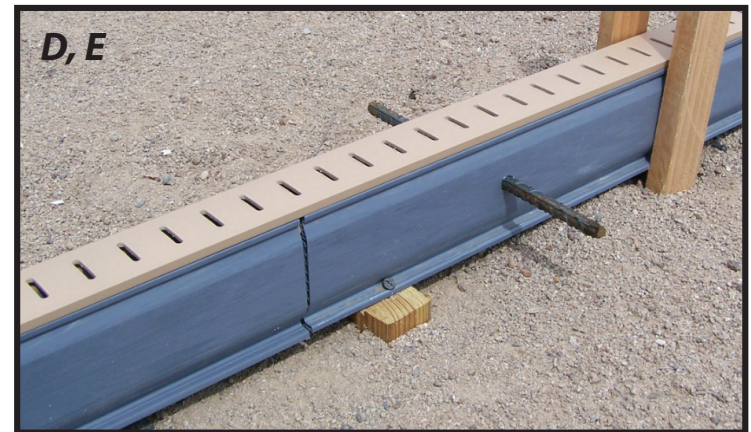

D. Install the top cap, making sure to "half-lap" the top past the joints to insure rigidity. Add additional stakes on either side of the drain to temporarily support the drain during the pour.

E. Using 3/8" Stegmeier Drain Dowel, drill and pin (midway through the base) every 3 feet to ensure against possible damage to the drain due to deck movement.

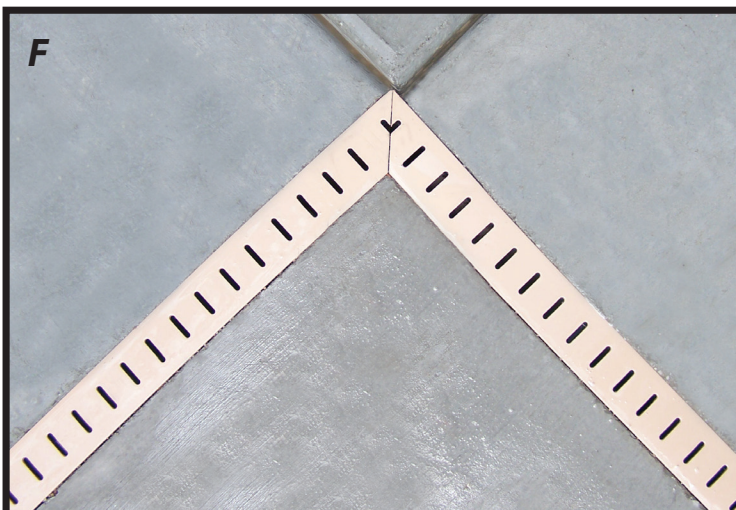

F. The fittings (90 degree, 45 degree, etc.) are supplied as "base only". During installation, the top caps (10 ft. long) run continuously over the fittings serving as a mounting device, leaving the fittings virtually invisible.

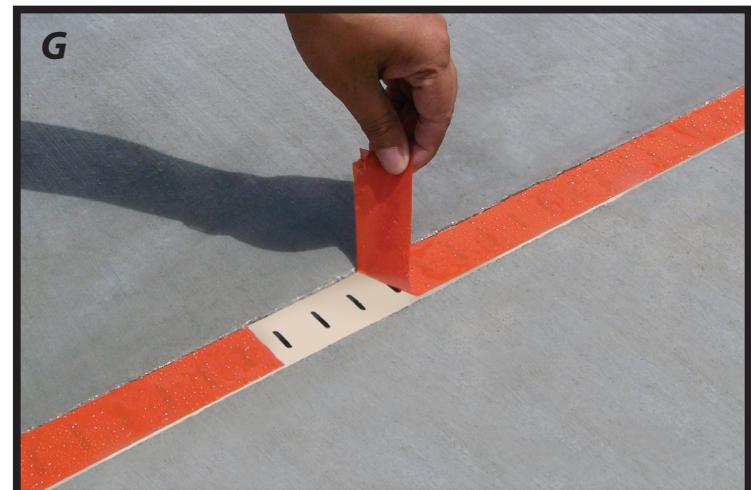

G. Remove the protective tape after the concrete installation is complete.

Caution: Leaving the protective tape in place for an extended period of time may result in the tape being difficult to remove.

EASY ACCESS/ MAINTENANCE

SNUG FITTING CAPS

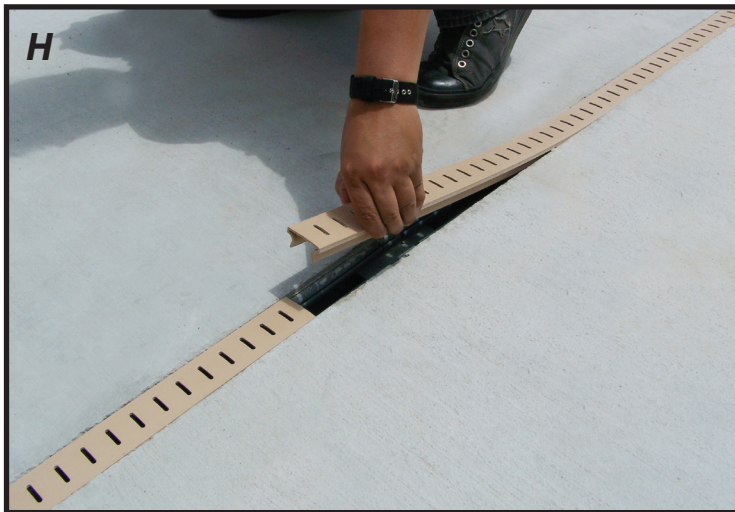

CLEAN OUT ACCESS



H, I. The top caps can be easily removed for cleaning or replacement. The top cap snaps in and out using the flex in the top cap legs. This unique attachment has no external fasteners (screws) that detract from the attractive appearance.

The Wet Pad Option

J. Using a string line, stake the drain into place. Fasten the drain to elevation temporarily, using screws or nails as needed. See Fig. J

K. Using sand and cement (mixed on site) apply a shovel full of mortar to each side of the drain 3 foot on center or as needed. See Fig. K

Using a trowel, push the mortar against the drain, making sure that the mortar does not extend above the top of the drain. See Fig. K

Many contractors prefer using the wet pad method because of the following advantages:

1. Provides a more stable surface to screed on.
2. Many municipalities prohibit leaving wooden stakes in the subsoil.

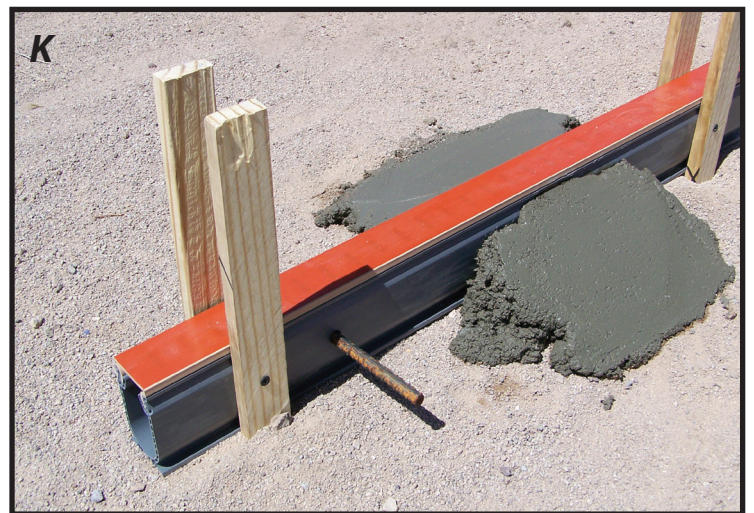
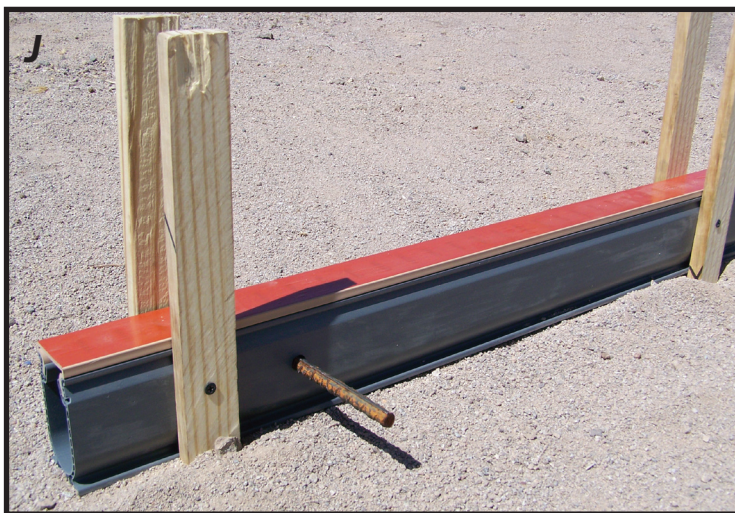
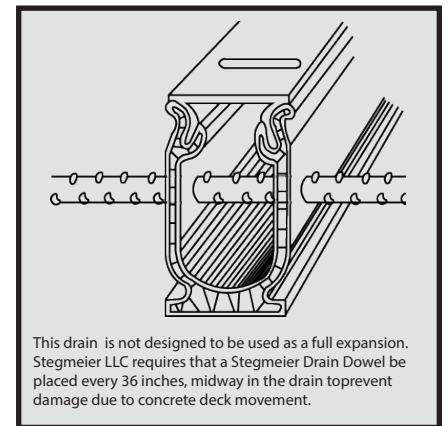

STEGMEIER[®]

LLC

1111 W. Harris Rd. Arlington TX, 76001
Customer Service - 800-382-5430 • Toll-free Fax - 800-356-3602
www.stegmeier.com